

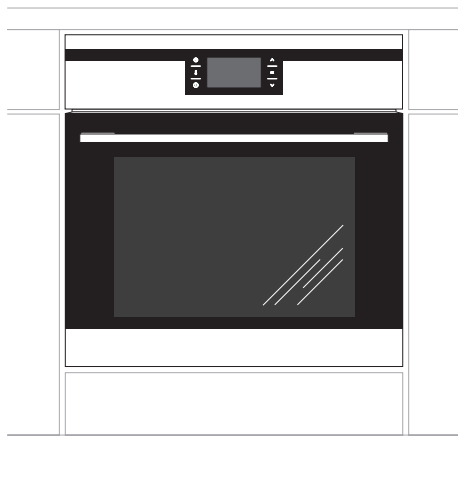

**MORRIS**

**MOF-64515**



**(EN) INSTRUCTION MANUAL**

## DEAR CUSTOMER,

---

*The oven is exceptionally easy to use and extremely efficient. After reading the instruction manual, operating the oven will be easy.*

*Before being packaged and leaving the manufacturer, the oven was thoroughly checked with regard to safety and functionality.*

*Before using the appliance, please read the instruction manual carefully. By following these instructions carefully you will be able to avoid any problems in using the appliance.*

*It is important to keep the instruction manual and store it in a safe place so that it can be consulted at any time. It is necessary to follow the instructions in the manual carefully in order to avoid possible accidents.*



**Caution!**

*Do not use the oven until you have read this instruction manual.*

*The oven is intended for household use only.*

*The manufacturer reserves the right to introduce changes which do not affect the operation of the appliance.*

# TABLE OF CONTENTS

---

<b>Safety instructions</b> .....	4
<b>Description of the appliance</b> .....	8
<b>Installation</b> .....	10
<b>Operation</b> .....	12
<b>Baking in the oven – practical hints</b> .....	32
<b>Cleaning and maintenance</b> .....	34
<b>Technical data</b> .....	40

## SAFETY INSTRUCTIONS

---

**Warning:** The appliance and its accessible parts become hot during use. Care should be taken to avoid touching heating elements. Children less than 8 years of age shall be kept away unless continuously supervised.

This appliance can be used by children aged from 8 years and above and persons with reduced physical, sensory or mental capabilities or lack of experience and knowledge if they have been given supervision or instruction concerning use of the appliance in a safe way and understand the hazards involved. Children shall not play with the appliance. Cleaning and user maintenance shall not be made by children without supervision.

During use the appliance becomes hot. Care should be taken to avoid touching heating elements inside the oven.

Accessible parts may become hot during use. Young children should be kept away.

**Warning:** Do not use harsh abrasive cleaners or sharp metal scrapers to clean the oven door glass since they can scratch the surface, which may result in shattering of the glass.

## SAFETY INSTRUCTIONS

---

**Warning:** Ensure that the appliance is switched off before replacing the lamp to avoid the possibility of electric shock.

Use only original temperature probe supplied with the appliance.

You should not use steam cleaning devices to clean the appliance.

- Ensure that small items of household equipment, including connection leads, do not touch the hot oven as the insulation material of this equipment is usually not resistant to high temperatures.
- Do not leave the oven unattended when frying. Oils and fats may catch fire due to overheating or boiling over.
- Do not put pans weighing over 15 kg on the opened door of the oven.
- Do not use harsh cleaning agents or sharp metal objects to clean the door as they can scratch the surface, which could then result in the glass cracking.
- Do not use the oven in the event of a technical fault. Any faults must be fixed by an appropriately qualified and authorised person.
- In the event of any incident caused by a technical fault, disconnect the power and report the fault to the service centre to be repaired.
- The rules and provisions contained in this instruction manual should be strictly observed. Do not allow anybody who is not familiar with the contents of this instruction manual to operate the oven.
- The appliance has been designed only for cooking. Any other use (for example for heating) does not comply with its operating profile and may cause danger.

## HOW TO SAVE ENERGY

---

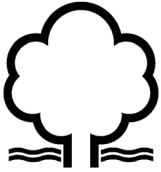

Using energy in a responsible way not only saves money but also helps the environment. So let's save energy! And this is how you can do it:

- **Do not uncover the pan too often (a watched pot never boils!).**

Do not open the oven door unnecessarily often.

- **Only use the oven when cooking larger dishes.**

Meat of up to 1 kg can be prepared more economically in a pan on the cooker hob.

- **Make use of residual heat from the oven.**

If the cooking time is greater than 40 minutes switch off the oven 10 minutes before the end time.

**Important!** When using the timer, set appropriately shorter cooking times according to the dish being prepared.

- **Make sure the oven door is properly closed.**

Heat can leak through spillages on the door seals. Clean up any spillages immediately.

- **Do not install the cooker in the direct vicinity of refrigerators/freezers.**

Otherwise energy consumption increases unnecessarily.

## UNPACKING



During transportation, protective packaging was used to protect the appliance against any damage. After unpacking, please dispose of all elements of packaging in a way that will not cause damage to the environment.

All materials used for packaging the appliance are environmentally friendly; they are 100% recyclable and are marked with the appropriate symbol.

Caution! During unpacking, the packaging materials (polythene bags, polystyrene pieces, etc.) should be kept out of reach of children.

## DISPOSAL OF THE APPLIANCE



Old appliances should not simply be disposed of with normal household waste, but should be delivered to a collection and recycling centre for electric and electronic equipment. A symbol shown on the product, the

instruction manual or the packaging shows that it is suitable for recycling.

Materials used inside the appliance are recyclable and are labelled with information concerning this. By recycling materials or other parts from used devices you are making a significant contribution to the protection of our environment.

Information on appropriate disposal centres for used devices can be provided by your local authority.

# DESCRIPTION OF THE APPLIANCE

*Electronic programmer*

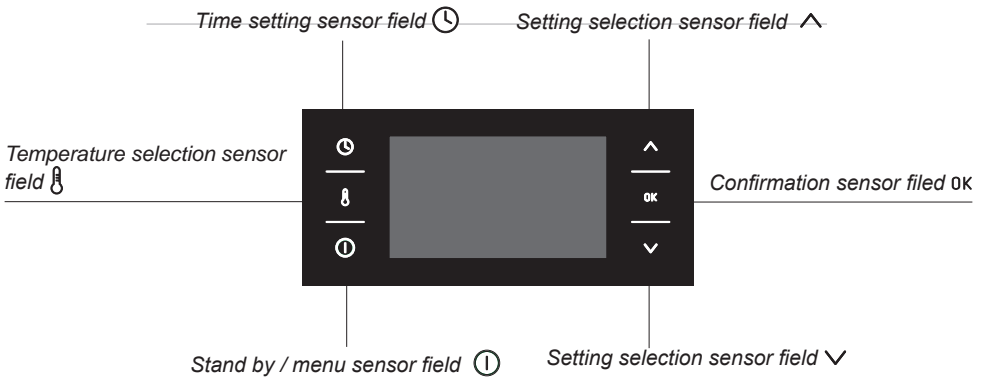
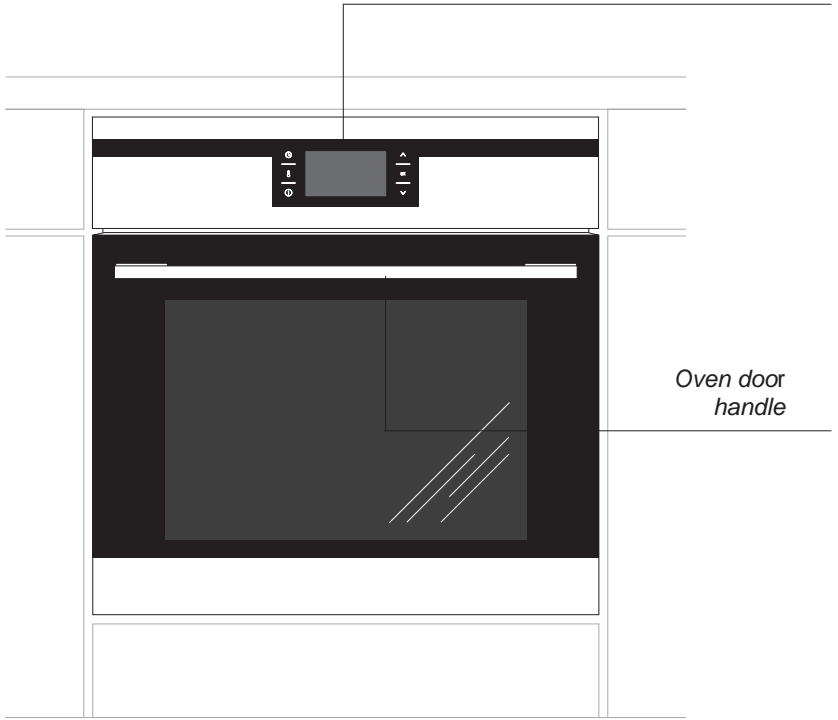



## SPECIFICATIONS OF THE APPLIANCE

---

Oven fittings:

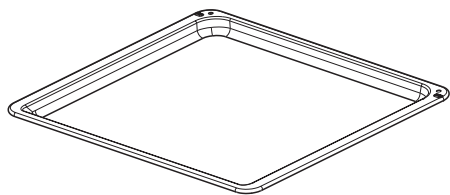

*Baking tray\**

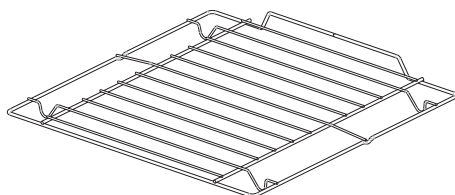

*Grill grate  
(drying rack)*

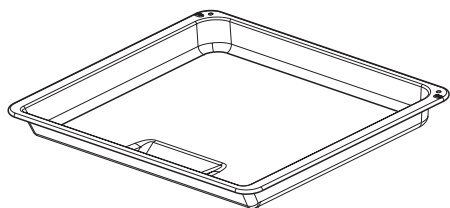

*Roasting tray\**

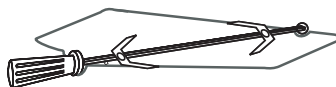

*Fork and rotisserie frame\**

*Sideracks*

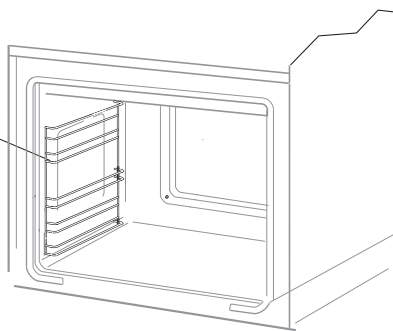

*\*optional*

# INSTALLATION

## Installing the oven

- The kitchen area should be dry and aired and equipped with efficient ventilation. When installing the oven, easy access to all control elements should be ensured.
- This is a Y-type design built-in oven, which means that its back wall and one side wall can be placed next to a high piece of furniture or a wall. Coating or veneer used on fitted furniture must be applied with a heat-resistant adhesive (100°C). This prevents surface deformation or detachment of the coating.
- Hoods should be installed according to the manufacturer's instructions.
- Make an opening with the dimensions given in the diagram for the oven to be fitted.
- Make sure the mains plug is disconnected and then connect the oven to the mains supply.
- Insert the oven completely into the opening without allowing the four screws in the places shown in the diagram to fall out.

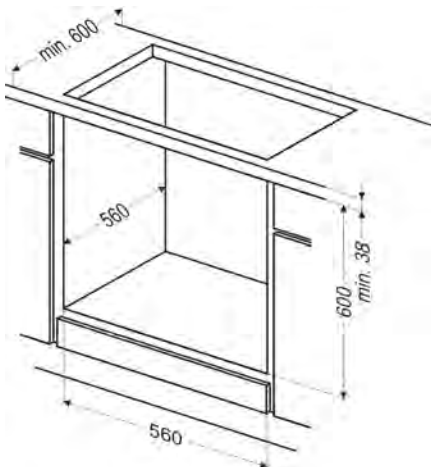
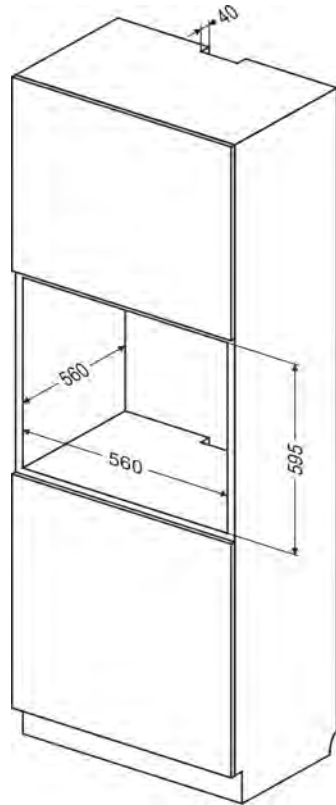

# INSTALLATION

---

## Electrical connection

- The oven is manufactured to work with a one-phase alternating current (230V 1N~50 Hz) and is equipped with a 3 x 1,5 mm<sup>2</sup> connection lead of 1.5 mm length with a plug including a protection contact.
- A connection socket for electricity supply should be equipped with a protection pin and may not be located above the cooker. After the cooker is positioned, it is necessary to make the connection socket accessible to the user.
- Before connecting the oven to the socket, check if:
  - the fuse and electricity supply are able to withstand the cooker load,
  - the electricity supply is equipped with an efficacious ground system which meets the requirements of current standards and provisions,
  - the plug is within easy reach.

### **Important!**

If the fixed power supply cable is damaged, it should be replaced at the manufacturer or at an authorized servicing outlet, or by a qualified person to avoid danger.

## OPERATION

---

### Before using the appliance for the first time

- Remove packaging, clean the interior of the oven,
- Take out and wash the oven fittings with warm water and a little washing-up liquid,
- Switch on the ventilation in the room or open a window,
- Heat up the oven (to a temperature of 250°C for approximately 30 minutes), remove any stains and wash the interior carefully. (see section: Electronic programmer operation and oven control)

### **Important!**

To clean the oven, only use a cloth well wrung out with warm water to which a little washing-up liquid has been added.

### **Important!**

Oven is equipped with a programmer with display controlled by six sensor fields located symmetrically on both sides of the display. To activate each sensor field, touch the glass above the sensor (indicated by a pictogram). An acoustic signal will be heard, which was selected in the menu. (See section: Electronic programmer operation and oven control.)

**Sensor field surfaces must be kept clean.**

# OPERATION





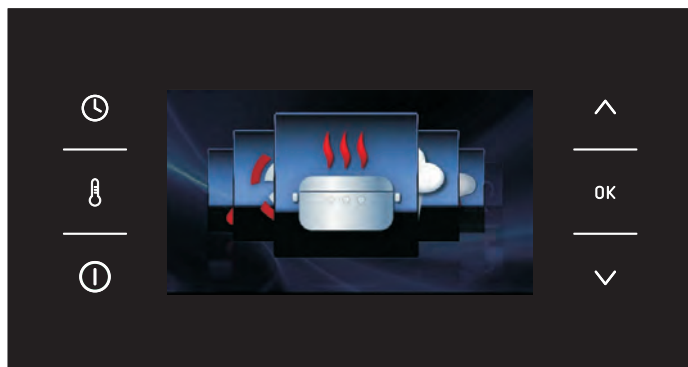

---

## Electronic programmer operation and oven control





---



### Sensor field functions

-  - time setting sensor
-  - field
-  - temperature
-  - selection sensor field
-  - stand by / menu sensor field
-  - setting selection sensor field

### Function symbols

-  - power cut-off
-  - temperature adjustment
-  - end time
-  - cook time
-  - Child Lock

# OPERATION

---

## Switching on the appliance and selecting language.

After connecting the appliance to the mains, electronic programmer starts in menu: setup / language.

Using the  $\nabla$   $\wedge$  sensor fields search the contents of the language menu. Touch  $\text{OK}$  sensor field to select the highlighted language in which you want the messages to be displayed.

When mains power is cut and restored (loss of power), electronic programmer automatically goes into standby and immediately displays the current time.

## Set current time.

Once language is selected, confirm the time displayed on the display using the  $\text{OK}$  sensor field or change it using the  $\nabla$   $\wedge$  sensor fields.

Time can be set in the range from 0:00 to 23:59 for 24-hour clock system or from 0:00 to 12:00 for the 12-hour clock system.

When current time is set, electronic programmer goes into standby mode in which the display shows the current time only.

To activate the appliance from standby and set current time, touch the  $\text{I}$  sensor field. When menu is displayed, select "setup" using the  $\nabla$   $\wedge$  sensor fields and confirm by touching  $\text{OK}$ . Upon accessing the "time" menu using the  $\nabla$   $\wedge$  sensor fields, select "current time" and confirm by touching  $\text{OK}$ .

### **Important!**

To exit to submenu at any time simultaneously touch  $\wedge$  and  $\text{OK}$  sensor fields.

# OPERATION

---

## Menu

Touch  to activate the appliance from standby. Use  $\nabla$   $\blacktriangle$  sensor fields to navigate the menu.

The following main menu items are available:

- setup,
- heating functions,
- preset programmes,
- user programmes,
- cleaning,
- exit.

Touch OK sensor field to select any menu item.

If no changes are made within 60 seconds, the appliance enters standby mode. To immediately exit from the menu and switch the appliance to standby mode, select the exit icon and touch OK to confirm. To immediately exit from the menu and switch the appliance to standby mode simultaneously touch  $\nabla$  sensor field and OK.

## Menu \ Setup

Touch  sensor field to enter the menu. Use  $\nabla$   $\blacktriangle$  sensor fields to select the “setup” menu and confirm the selection by touching OK.

The following setup menu items are available:

- language,
- time
- lighting,
- sound,
- themes,
- brightness,
- service,
- factory settings,
- exit.

Use  $\nabla$   $\blacktriangle$  sensor fields to navigate the menu. Touch OK to select the chosen item.

To exit from the setup menu, select exit and touch OK to confirm. To immediately exit from the setup menu and switch the appliance to standby mode simultaneously touch  $\nabla$   $\blacktriangle$  sensor field and OK.

## Menu \ Setup \ Language

Select the required language using the  $\nabla$   $\blacktriangle$  sensor fields and confirm selection by touching OK.

The following language menu items are available:

- Deutsch,
- English,
- Polski,
- По русски,
- Česky,
- Srbski,
- Lietuviškai,
- Eesti,
- Latviski,
- Français,
- Español,
- Türkçe,
- Svenska,
- Norsk,
- Suomi,
- Dansk,
- Italiano,
- Exit,

## OPERATION

For details on how to select language, please refer to section **Switching on the appliance and selecting language**.

To exit from the language menu to setup menu, select exit using the  $\vee$   $\wedge$  navigation sensor fields and touch OK to confirm.

To immediately exit from the language menu to setup menu and then to main menu touch  $\wedge$  sensor field and OK.

### Menu \ Setup \ Time

Select the time menu using the  $\vee$   $\wedge$  sensor fields and confirm selection by touching OK. The following time menu items are available:

- current time,
- kitchen timer,
- clock type,
- time format,
- exit.

Use the navigation sensor fields  $\vee$   $\wedge$  to select one of the menu items above and touch OK sensor field to confirm.

### Menu \ Setup \ Time \ Current Time

For details on how to set current time, please refer to section Setting current time.

### Setting cook time (for a heating function)

Once heating function is selected, touch  $\text{🕒}$  sensor field. When  $\text{▶|}$ , starts to flash on the display, near box 1 displaying the temperature, box 2 will appear displaying COOK TIME and the time display shows "0:00".

The display before setting cook time or cook time and end time - box 2 is in active.



The display showing cook time for cook time and end time - box 2 is active



If no change in setting is made within 5 seconds the display will show target and current temperature, box 2 will be deactivated and  $\text{▶|}$ .

symbol will stop flashing.

Touch  $\vee$   $\wedge$  navigation sensor fields to set cook time in 1 minute steps. Cook time is stored after 5 seconds or after touching OK sensor field.



## OPERATION

COOK TIME changes to END TIME in box 2. Entered cook time, for example 0:30, changes to the actual end time, while the remaining time is displayed on the red bar below the actual end time .

symbol is displayed continuously. Once cook time has elapsed, an acoustic signal is sounded (2 beeps / pause / 2 beeps). The sequence is repeated every 3 seconds for about a minute,  symbol is flashing.





Touch OK to acknowledge and mute the acoustic signal. After this, the appliance switches to standby mode.

**Important.** Once the cook time has elapsed you can extend it. Touch OK instead of  and set the additional time using navigation sensor fields.



### .Setting Cook Time and End Time (for a heating function)

For details on how to set Cook Time, please refer to the preceding paragraph.



#### Setting End Time.

When  is displayed continuously, touch  sensor field again. While  symbol continues to be displayed, , symbols starts flashing and End Time is shown on the display.





If no change in setting is made within 5 seconds, the appliance will return to previous settings of cook time and the selected heating function. Touch   navigation sensor fields to set cook time in 1 minute steps.

Cook time is stored after 5 seconds or after touching OK sensor field.

COOK TIME changes to START TIME in box 2. Entered cook time changes to the actual start time , symbol is displayed continuously, while  symbol is extinguished. If no changes are made within 60 seconds, the appliance enters standby mode. When any sensor field is touched, the appliance is activated and the display shows last settings.

#### Appliance operation in selected mode

When the current time reaches start time, the appliance will start the selected heating function. START TIME changes to END TIME in box 2. The display shows end time and the time remaining to end time is displayed on the red bar below the actual end time. When cook time countdown begins the , symbol is extinguished and  symbol illuminates.

## OPERATION

Once cook time has elapsed, an acoustic signal is sounded (4 beeps / pause / 4 beeps). The sequence is repeated every 3 seconds for about a minute. The symbol is flashing. Touch OK to acknowledge and mute the acoustic signal. The appliance switches to standby mode.

### Menu \ Setup \ Time \ Timer

After confirming the selection of kitchen timer with OK the appliance displays the time in the format: 00:00.

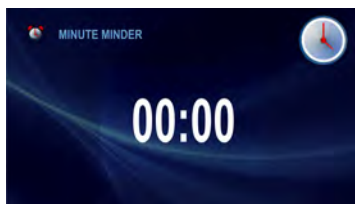

If no changes are made within 5 seconds, the appliance enters standby mode.

Touch navigation sensor fields to set kitchen timer time in 1 minute steps. Counting down starts after 5 seconds or after touching OK sensor field.

Touch the  sensor field to change the kitchen timer setting during countdown.

Once set time has elapsed, an acoustic signal is sounded (2 beeps / pause / 2 beeps). The sequence is repeated and 00:00 is displayed.

Touch OK to acknowledge and mute the acoustic signal. After this, the appliance switches to standby mode.

### Menu \ Setup \ Time \ Clock type

Select clock type menu and touch OK. The following items will be available:

- Standard
- digital,
- analogue

Select the clock type using the  $\vee$   $\wedge$  sensor fields and confirm selection by touching OK. The selection is stored by the appliance and upper level menu is automatically displayed. The selected clock will now appear in the upper right corner of the display and during standby.

### Menu \ Setup \ Time \ Time Format

Select Time Format menu and touch OK. The following items will be available

- 24h,
- AM / PM.

Select the time format using the  $\vee$   $\wedge$  sensor fields and confirm selection by touching OK. The selection is stored by the appliance and upper level menu is automatically displayed.

This option is only available for a standard and digital clock.

# OPERATION

---

## Menu \ Setup \ Lighting

Select Lighting menu and touch OK, The following items will be available:

- continuous,
- intermittent.

Select the oven chamber lighting option using the  $\nabla$   $\blacktriangle$  sensor fields and confirm selection by touching OK. The selection is stored by the appliance and upper level menu is automatically displayed.

### Continuous

When continuous lighting is selected, light will be on continuously during a programme (heating function) or when oven door is opened.

### Intermittent

When intermittent lighting is selected, light will be on for 30 seconds from starting a programme (heating function) and then light is turned off. Touch any sensor field to turn the light back on during oven operation. Light will be turned off again after 30 seconds of touching the sensor field. When oven door is opened, light is turned on for as long as the oven door is open, but no longer than 10 minutes, after which the light is turned off.

## Menu \ Setup \ Sound

Select Sound menu and touch OK, The following items will be available:

- Tone\_1
- Tone\_2
- Tone\_3
- silent (this applies to keys, not the alarm)

Select the sound option using the  $\nabla$   $\blacktriangle$  sensor fields and confirm selection by touching OK.

The selection is stored by the appliance and upper level menu is automatically displayed.

## Menu \ Setup \ Themes

Select Themes menu and touch OK, The following items will be available:

- Theme\_1
- Theme\_2
- Theme\_3

Select the theme option using the  $\nabla$   $\blacktriangle$  sensor fields and confirm selection by touching OK.

The selection is stored by the appliance and upper level menu is automatically displayed.

## OPERATION

---

### Menu \ Setup \ Brightness

Select Brightness menu and touch OK, The following screen will be displayed:



Touch  $\nabla$   $\blacktriangle$  navigation sensor fields to adjust display brightness within 0-100% range in 1% steps. Touch OK to store the selected display brightness level. The selection is stored by the appliance and upper level menu is automatically displayed.

### Menu \ Setup \ Service

Select Service menu and touch OK, The following screen will be displayed:

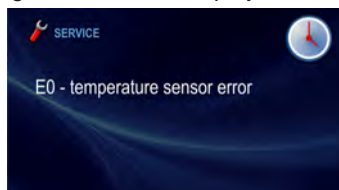

If the appliance detects an error, its code will be displayed as shown above.

If E1 error is detected by the appliance, meat temperature probe can't be used. If an attempt is made to select a programme where the meat probe is used, the appliance will display service screen showing E1 error and its brief description. You can continue to use the appliance on the programs do not require meat probe. Touch OK to acknowledge service screen and go to main menu.

If no sensor field is touched within 10 seconds when E1 error service screen is displayed, the appliance will automatically go into standby.

### Menu \ Setup \ Factory Settings

Select Factory Settings menu and touch OK, The following screen will be displayed:

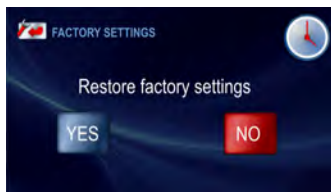

Touch  $\nabla$   $\blacktriangle$  navigation sensor fields to select whether to restore the factory settings or leave the current settings. To keep current settings, select "No" and confirm by touching OK sensor field. The appliance goes to upper menu level.

To restore factory settings select "Yes" and confirm by touching OK sensor field. The factory settings will be restored.

# OPERATION

## Menu \ Heating Functions

Select the Heating Functions menu using the  $\nabla$   $\blacktriangle$  sensor fields and confirm selection by touching OK.

The following heating functions are available:

- conventional,
- cake,
- turnspit \*,
- grill,
- turbo grill,
- super grill,
- fan cooking,
- pizza,
- browning,
- roasting,
- defrosting,
- super spit \*.

Overview of functions, oven elements to implement them and the range of possible temperature settings and default settings.

No.	Function Description	Oven elements	Temperature		Default temperature	Oven level
			min.	max.		
1	Conventional,	bottom heater + top heater	30	280	180	3
2	Cake,	bottom heater + top heater + fan	30	280	170	3
3	Turnspit	grill + turnspit	30	280	280	-
4	Grill	grill	30	280	280	4
5	Turbo grill	grill + fan	30	280	200	2
6	Super grill	grill + top heater	30	280	280	4
7	Fan cooking	fan heater + fan	30	280	170	3
8	Pizza	fan heater + bottom heater + fan	30	280	220	2
9	Browning	top heater	30	230	180	-
10	Roasting,	bottom heater	30	240	200	-
11	Defrosting	fan	30	-	-	3
12	Super spit	grill+ top heater + turnspit	30	280	280	-

\* for models equipped with turnspit

# OPERATION

## Menu \ Heating Functions \ Fan cooking

Select the Fan Cooking menu using the  $\nabla$   $\blacktriangle$  sensor fields and confirm selection by touching OK. The following screen is displayed showing the default temperature of 170°C and level three.



$\downarrow$  symbol flashes for 5 seconds when the screen is displayed. During this time it is possible to adjust temperature to any other temperature within the allowed range (see table). Touch  $\nabla$   $\blacktriangle$  sensor fields to adjust temperature. Wait 5 seconds or touch OK sensor field to store the new temperature  $\downarrow$  is flashing.

Touch  $\uparrow$  sensor field to adjust temperature again. Touch OK to start the programme. The following operate: cooling fan motor, lighting, fan cooking motor and fan heater. Fan heater is operates intermittently (thermostat) ensuring stable temperature in the oven chamber. Current oven chamber temperature is displayed, "Now 165°C".

**Important.** The appliance will beep three times once the set temperature is reached in the oven chamber.

Touch  $\text{⓪}$  sensor field to turn off the appliance when no cook time is set. All functions except cooling fan are then turned off (see: **Cooling fan operation**) and the appliance goes into standby.

## ECO function

Eco function allows the use of residual heat in the oven chamber to heat food. Eco function is available for the following heating functions:



The Eco function involves disconnecting the heater 5 minutes before cook time elapses.



## OPERATION

### Using meat (food) temperature probe



After selecting the chosen heating function, set the desired cooking temperature, or accept the default temperature. Connect meat probe to appropriate socket. Default meat probe temperature of 80°C is shown in box 2 on the display.







When meat probe is connected  flashes for 5 seconds. If no changes are made within 5 seconds, currently displayed temperature is set for the meat probe.

Touch   sensor fields to adjust temperature in the range 30 to 99°C in 1°C steps. The set temperature is stored after 5 seconds, and current temperature measure by the meat probe is displayed  symbol is also continuously displayed.

It is also possible to change temperature during cook time countdown. To do so, touch .

After the first touching  temperature set for the meat probe is displayed  is flashing and it is possible to adjust the temperature.

5 seconds after the last change of setting, the  symbol stops flashing and the appliance continues normal operation.

If the sensor field is touched again within 5 seconds  symbol stops flashing and actual temperature measured by the meat probe is displayed in the box. At the same time  symbol starts flashing and oven chamber temperature can be adjusted. 5 seconds after the last change of setting, the  symbol stops flashing and the appliance continues normal operation.

Once the food reaches the set temperature, all functions except cooling fan are turned off (see: Cooling fan operation) and an acoustic signal is sounded (4 beeps / pause / 4 beeps).

The sequence is repeated every 3 seconds for about 5 minutes. The display shows the temperature set for the oven chamber and for the meat probe and  symbol is flashing.

Touch OK, to acknowledge and mute the acoustic signal. All functions except cooling fan are then turned off (see: Cooling fan operation) and the appliance goes into standby.

Opening the door during cook time disconnects the heating elements and convection fan motor (if used).

The use of temperature probe is recommended when cooking large portions of meat (at least 1 kg).

The use of temperature probe is not recommended when cooking poultry and meat with bones.

## OPERATION

When not in use, disconnect the temperature probe from its socket and remove from oven chamber.

### Important!

Use only original temperature probe supplied with the appliance.



### Recommended probe temperature settings

Type of meat	Temperature [°C]
Pork	85 - 90
Beef	80 - 85
Veal	75 - 80
Lamb	80 - 85
Venison	80 - 85

### Special functions

#### Child Lock

Simultaneously touch OK and ^ for approximately 3 seconds to active child lock. When Child Lock function is set the  symbol and the message "Touch √ and OK. to release Child Lock" are displayed. The message will be displayed for 3 seconds. When Child Lock is active the message is displayed each time any sensor is touched.

When child lock is enabled, it is not possible to make any changes to the preset cooking programs. All the sensor fields, except OK, √ and  are inactive. When child lock is enabled touch OK together with √ to deactivate child lock, and also touch OK to acknowledge and mute the acoustic signal when programme has completed. When child lock is enabled  sensor field serves only to interrupt the program rather than access the menu. Touching any other sensor field when child lock is enabled is signalled by single long beep. This does not apply to the , sensor field, whose operation is as described above.

Releasing child lock. Simultaneously touch OK and √ for approximately 3 seconds to release child lock. When Child Lock function is released the  symbol and the message "Touch √ and OK to release Child Lock" go out.

**Important.** Child Lock continues to be active even after a power outage.



# OPERATION

## Automatic power cut out

If the oven operates any heating function for a long (excessive) period of time, heating elements are disconnected.

If all the heating elements are disconnected, this is indicated by a flashing  symbol.

To deactivate the automatic power cut out of heating elements, touch , in standby mode. The appliance exits to the main menu.

## Night Mode

Between 22:00 and 6:00 the appliance automatically switches to night mode dimming display backlight intensity.

## Open door alert

If the oven chamber door is opened during cooking, an acoustic signal will be sounded and the message DOOR OPEN will be displayed.

## **Menu / preset programmes**



Select Preset Programme menu and touch OK The following items will be available

- a) meat,
- b) poultry,
- c) pizza,
- d) frozen products,
- e) pastries,
- f) dough proving,
- g) drying,
- h) keeping the dough warm

## **Example: using a preset program with meat probe**

Select meat menu and confirm by touching OK. The following types of meat are available: pork, beef, veal, lamb. Select pork and a confirm selection by touching OK. The screen as shown below will be displayed and  will be flashing.



Plug in the meat probe and  symbol will stop flashing. If you touch OK sensor field when  symbol is flashing the appliance will interpret this as an illegal operation and an acoustic signal will be heard, while the display remains unchanged.

## OPERATION

Touch OK to start the programme.

You can modify temperature settings for chamber oven and meat probe at any time, however, making any changes will modify the preset program. Modifying one of the preset temperatures (🔥 or 🌀 stops flashing) changes the programme into fan cooking and pork symbol in the upper left corner of the display changes to fan cooking symbol. Touch ⏸ to stop the programme at any time. After this, the appliance switches to standby mode.

Once the food reaches the set temperature, all functions except cooling fan are turned off (see: Cooling fan operation) and an acoustic signal is sounded (4 beeps / pause / 4 beeps).

The sequence is repeated every 3 seconds for about 5 minutes. The display shows the temperature set for the oven chamber and for the meat probe and 🌀 symbol is flashing. Touch OK to acknowledge and mute the acoustic signal. After this, the appliance switches to standby mode.

### Example: using a preset program with no oven preheating

Select poultry menu and confirm by touching OK, The following types of poultry are available: chicken, duck, goose, turkey. Select chicken and a confirm selection by touching OK. The following screen is displayed showing the default temperature of 190°C and weight symbol in box 2.





Flashing weight symbol (scales), indicates that you can change weight or accept the default weight. If no changes are made within 3 minutes, the appliance switches to standby mode.

Touch ∨ ∨ sensor fields to change weight. Touch OK to accept weight shown on the display. END TIME is shown on the display in box 2, calculated based on accepted weight. The programme is started.

## OPERATION

The appliance display shows the following information when a program is in progress:



You can modify temperature settings for chamber oven or end time at any time, however, making any changes will modify the preset program. Modifying temperature or time:  or  (stops flashing) changes the chicken cooking programme into turbo grill programme and chicken symbol in the upper left corner of the display changes to turbo grill symbol. Touch  to stop the programme at any time. After this, the appliance switches to standby mode.

Once the cook time proportional to entered chicken weight elapses, all functions except cooling fan are turned off (see: **Cooling fan operation**) and an acoustic signal is sounded (4 beeps / pause / 4 beeps). The sequence is repeated every 3 seconds for about 5 minutes.

The display continues to show oven chamber temperature and  symbol is flashing. Touch OK to acknowledge and mute the acoustic signal. After this, the appliance switches to standby mode.

### Example: using a preset program with oven preheating

Select Pastries menu and confirm by touching OK. The following types of pastries are available: crumble cake, fruit cake, Swiss roll, sponge cake, muffins, cookies, bread. Select Swiss roll and confirm selection by touching OK. The following screen is displayed showing the default temperature of 200°C and inactive cook time (00:10) in box 2.



If no changes are made within 3 minutes, the appliance switches to standby mode.

Touch OK. to start the programme. Oven start preheating to 200°C.



Once the desired temperature of 200°C is reached, an acoustic signal is sounded (2 beeps / pause / 2 beeps) and  symbol is flashing. Box 2 showing cook time of 0:10 time is now active. The sequence is repeated every 3 seconds for about 5 minutes. Temperature of 200°C is maintained in oven chamber.

Place food in the open, close the door and touch OK sensor field to start the programme.

# OPERATION

Appliance display will show the following information



Desired temperature is maintained in the oven. COOK TIME in box 2 is replaced with END TIME (programme end time is displayed and the remaining time of 10 minutes on the progress bar). You can modify temperature settings for chamber oven or end time at any time, however, making any changes will modify the preset program. Modifying temperature or time (or  or  stops flashing) changes the Swiss roll programme into conventional programme and Swiss roll symbol in the upper left corner of the display changes to conventional cooking symbol.

Touch , to stop the programme at any time. After this, the appliance switches to standby mode.

Once the cook time proportional to entered chicken weight elapses, all functions except cooling fan are turned off (see: Cooling fan operation) and an acoustic signal is sounded (4 beeps / pause / 4 beeps). The sequence is repeated every 3 seconds for about 5 minutes.

The display shows the temperature set for the oven chamber and END TIME and  symbol is flashing.

Touch OK, to acknowledge and mute the acoustic signal. After this, the appliance switches to standby mode.

## Preset programmes

1. Meat
  - pork
  - beef
  - veal
  - lamb
2. Poultry
  - chicken
  - duck
  - goose
  - turkey
3. Pizza
  - thin base
  - thick base
  - frozen
4. Frozen products
  - fish
  - lasagne
  - chips
5. Pastries
  - crumble cake
  - fruitcake
  - cheesecake
  - Swiss roll
  - sponge cake
  - muffins
  - cookies
  - bread
6. Other functions
  - dough proving
  - drying
  - keeping food warm

# OPERATION

## Menu / user programs

Select user programmes menu and touch OK. 10 fully customisable user programmes are available.

### Operating user programmes

Using  $\nabla$   $\wedge$  navigation sensor fields, select a user program such as P0 and touch OK, to confirm your selection. The appliance display will show the default settings for all P0-P10 user programmes, which are the same as those shown below: conventional cooking, temperature 180°C and cook time 00:30.



If no changes are made within 3 minutes, the appliance switches to standby mode.

Place food in the open, close the door and touch OK. sensor field to start the programme. The programme is started. In box 2 of the pre-set programme COOK TIME changes to END TIME and consequently cook time of 0:30 is replaced with end time and the remaining time is shown on the progress bar.

Once the programmed cook time has elapsed, all functions except cooling fan are turned off (see: Cooling fan operation) and an acoustic signal is sounded (4 beeps / pause / 4 beeps).

The sequence is repeated every 3 seconds for about 5 minutes. The display shows the temperature set for the oven chamber and END TIME and  $\rightarrow$  symbol is flashing.

Touch OK, to acknowledge and mute the acoustic signal. After this, the appliance switches to standby mode.

### Editing user programme settings

To modify the heating function and COOK TIME, touch and hold  $\odot$  sensor field and then touch  $\wedge$ . sensor field. Function name and symbol start flashing in box 3. If no changes are made within 3 minutes, the appliance exits to upper menu (User Programmes) and stores settings last shown on the display. Only changes confirmed by touching OK are updated.

Touch  $\nabla$   $\wedge$ . navigation sensor fields to change the heating function. Available heating functions are described in section Menu \ Heating functions.

Select the desired function and touch OK. sensor field to confirm. After touching the OK sensor field, heating function symbol and name stop flashing in box 3. At the same time  $\downarrow$  symbol start flashing and it is possible to modify the temperature. If no changes are made within 3 minutes, the appliance exits to upper menu (User Programmes) and stores settings last shown on the display. Only changes confirmed by touching  $\downarrow$  are updated.

## OPERATION

---

Touch OK navigation sensor fields to change the temperature. Temperature range and default temperature are described in section Menu \ Heating functions. Select the desired temperature and touch  $\nabla$   $\blacktriangle$  sensor field to confirm. After touching the OK sensor field,  thermometer symbol stops flashing. At the same oven level symbol start flashing and it is possible to modify it.



If no changes are made within 3 minutes, the appliance exits to upper menu (User Programmes) and stores settings last shown on the display. Only changes confirmed by touching OK are updated.

Touch  $\nabla$   $\blacktriangle$  navigation sensor fields to change the oven level. Select the desired oven level and touch OK sensor field to confirm.

After touching the OK sensor field, oven level symbol stops flashing. At the same  cook time symbol start flashing and it is possible to modify it. If no changes are made within 3 minutes, the appliance exits to upper menu (User Programmes) and stores settings last shown on the display. Only changes confirmed by touching OK are updated.

Touch  $\nabla$   $\blacktriangle$  navigation sensor fields to change the cook time. Select the desired cook time and touch OK sensor field to confirm. After this, all selected and confirmed parameters are stored by the appliance and the appliance exits to upper menu (User Programmes).

When you re-enter P01 from the user programmes menu the appliance displays the last saved settings. Editing the settings for other programmes (P02-P10) is done in the same way.

Touch  or  sensor field to change time and temperature settings respectively during operation of a user program.

### User programme editing mode

To enter EDITING MODE select EDIT from the menu using  $\nabla$   $\blacktriangle$  navigation sensor fields and confirm selection by touching OK, Programme number will be displayed. Using  $\nabla$   $\blacktriangle$  navigation sensor fields, select a user programme such as PROGRAMME 1 and touch OK, to confirm your selection. The appliance display will show the default settings for all PROGRAM1 - PROGRAM 10 user programmes: conventional cooking, temperature 180°C and cook time 00:30. Flashing progress bar will show the successive steps and inactive screens will be dimmed.

Use the  $\nabla$   $\blacktriangle$  navigation touch sensors and OK to select:

- heating function
- temperature
- baking level
- cook time

Once cook time is confirmed, a keyboard will be displayed to enter a custom programme name. Touch OK to exit to user programmes menu. User custom programme name will be displayed under programme number.

Programme name may contain up to 25 characters.

For information on how to operate a user programme, please refer to Operating user programmes section.

# OPERATION

## Menu / Cleaning

Touch  $\vee$   $\wedge$  navigation sensor fields to select cleaning from main menu and touch OK. The following screen will be displayed:



If no changes are made within 3 minutes, the appliance switches to standby mode.

Pour water into baking tray, close the door and touch OK. sensor field to start the programme. The programme is started. In box 2 of the preset programme COOK TIME changes to END TIME and consequently cook time of 0:30 is replaced with end time and the remaining time is shown on the progress bar. Once the programmed cook time has elapsed, all functions except cooling fan are turned off (see: Cooling fan operation) and an acoustic signal is sounded (4 beeps / pause / 4 beeps).

The sequence is repeated every 3 seconds for about 5 minutes. The display shows the temperature set for the oven chamber and END TIME and  $\Rightarrow$  symbol is flashing.

Touch OK to acknowledge and mute the acoustic signal. After this, the appliance switches to standby mode.

## Cooling fan operation

Cooling fan is started whenever oven chamber temperature exceeds 50°C regardless of any heating function operating or not. In order for the cooling fan to be started both protection relay and cooling fan delay must be on.

Once cooking is finished the display shows current time and oven chamber temperature bar.

## Lighting

According to an option selected in Menu / Setup / Lighting, lighting is switched on when any heating function is in operation. Regardless of the option selected in Menu / Setup / lighting, light illuminates continuously when oven chamber door is opened and it turns off when the door is closed.

Opening the door during cook time disconnects the heating elements and convection fan motor (if used). Normal operation is resumed after that door is closed.

## BAKING IN THE OVEN – PRACTICAL HINTS

---

### Baking

- we recommend using the baking trays which were provided with your cooker;
- it is also possible to bake in cake tins and trays bought elsewhere which should be put on the drying rack; for baking it is better to use black trays which conduct heat better and shorten the baking time;
- shapes and trays with bright or shiny surfaces are not recommended when using the conventional heating method (top and bottom heaters), use of such tins can result in undercooking the base of cakes;
- when using the ultra-fan function it is not necessary to initially heat up the oven chamber, for other types of heating you should warm up the oven chamber before the cake is inserted;
- before the cake is taken out of the oven, check if it is ready using a wooden stick (if the cake is ready the stick should come out dry and clean after being inserted into the cake);
- after switching off the oven it is advisable to leave the cake inside for about 5 min.;
- temperatures for baking with the ultra-fan function are usually around 20 – 30 degrees lower than in normal baking (using top and bottom heaters);
- the baking parameters given in Table are approximate and can be corrected based on your own experience and cooking preferences;
- if information given in recipe books is significantly different from the values included in this instruction manual, please apply the instructions from the manual.

### Roasting meat

- cook meat weighing over 1 kg in the oven, but smaller pieces should be cooked on the gas burners.
- use heatproof ovenware for roasting, with handles that are also resistant to high temperatures;
- when roasting on the drying rack or the grate we recommend that you place a baking tray with a small amount of water on the lowest level of the oven;
- it is advisable to turn the meat over at least once during the roasting time and during roasting you should also baste the meat with its juices or with hot salty water – do not pour cold water over the meat.



# BAKING IN THE OVEN – PRACTICAL HINTS

---

## Use of the rotisserie

---

The rotisserie enables rotating grilling in the oven. It is intended for grilling poultry, kebabs, sausages and similar dishes. Switching the rotisserie motor on and off is done at the same time as switching the grilling function with rotisserie turnspit, super spit.

When using these functions during grilling the rotisserie motor can stop momentarily or the rotating direction can be changed. This does not affect the functionality and the grilling quality.

Preparing dishes using the rotisserie:  
(see the diagram below)

- put the food on the rotisserie spit and secure it using the forks;
- insert the rotisserie frame into the oven on the third level from the bottom;
- insert the spit end into the motor drive coupling, making sure that the groove of the metal part of the rotisserie handle rests on the frame;
- unscrew the handle;
- insert the tray onto the lowest level of the oven chamber and close the door.

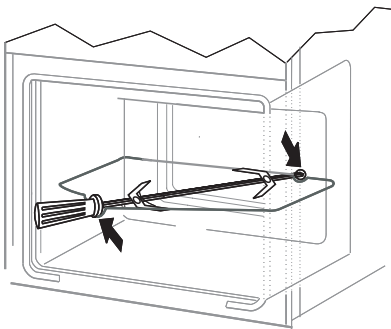

## CLEANING AND MAINTENANCE

---

Proper routine maintenance and cleaning of the oven can significantly extend its trouble-free operation.

**Turn off the oven before cleaning. Do not begin cleaning until the oven has cooled.**

- Clean the oven after each use. When cleaning the oven turn on lights to improve visibility of the interior.
- To clean the oven, only use a cloth well wrung out with warm water to which a little washing-up liquid has been added.
- **Aqualytic function**

Proceed as described in the section Menu and Cleaning

When the steam cleaning process is completed, wipe out the chamber with a damp cloth or a sponge soaked in a mild solution of washing-up liquid.

- After cleaning wipe over chamber dry.
- Use a soft, moisture absorbing cloth to clean surfaces

### **Important!**

**Do not use any abrasive agents, harsh detergents or abrasive objects for cleaning.**

**Only use warm water with a small addition of dishwashing liquid to clean the front of the appliance. Do not use washing powders or creams.**

# CLEANING AND MAINTENANCE

## Dismounting the side racks

Ovens marked with the letter **D** are equipped with easily removable wire shelf supports. To remove them for washing, pull the catch on the front (Z1), then swing the support and remove from the rear catch (Z2). After cleaning the shelf supports, place them in support holes in the oven and press in the catches (Z1 and Z2).

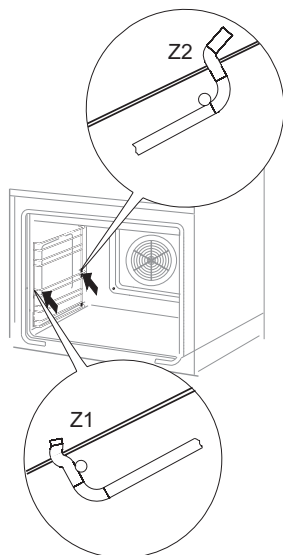

*Dismantling shelf supports*

Ovens marked with the letters **Da**, have stainless steel sliding telescopic shelf supports attached to the wire shelf supports. The telescopic shelf supports should be removed and cleaned with the wire shelf supports. Before you put the baking tray on them, they should be pulled out (if the oven is hot, pull out the telescopic shelf supports by hooking the rear edge of the baking tray at the front of the telescopic shelf supports) and then slide along with the tray.

## Removing telescopic shelf supports

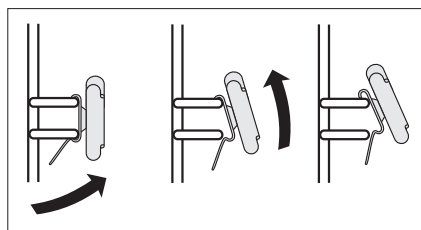

## Installing telescopic shelf supports

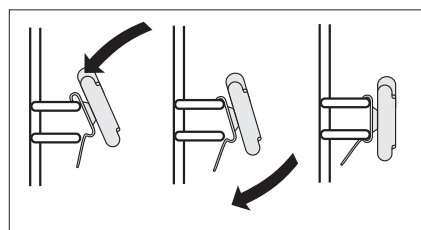

### **Important!**

Do not wash telescopic shelf supports in a dishwasher.

# CLEANING AND MAINTENANCE

## Replacing halogen lighting in the oven

**Before replacing the halogen bulb, make sure the appliance is disconnected from electric mains to avoid possible electric shock.**

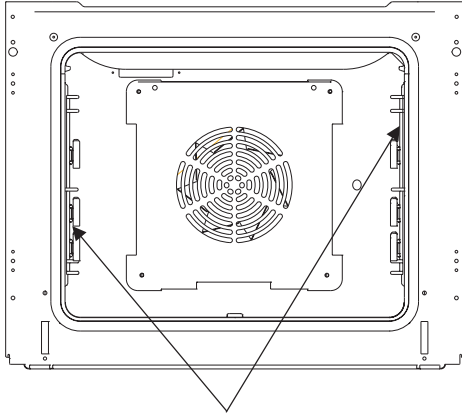

*Oven lighting*

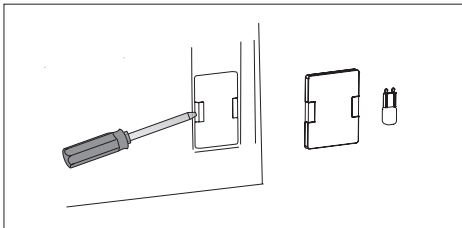

1. Disconnect power from oven
2. Remove shelves and trays from the oven.
3. If the oven has telescopic shelf supports, remove them also.
4. Use a flat screwdriver to pry the lamp cover loose, remove it, wash and carefully wipe dry.
5. Pull the halogen bulb out by sliding it down using a cloth or paper. If necessary, replace the halogen bulb with a new one G9, 230V, 25W.
6. Replace the halogen bulb in its socket.
7. Replace lamp cover

**Note: Make sure not to touch the halogen directly with your fingers!**

# CLEANING AND MAINTENANCE

## Door removal

In order to obtain easier access to the oven chamber for cleaning, it is possible to remove the door. To do this, tilt the safety catch part of the hinge upwards (fig. A). Close the door lightly, lift and pull it out towards you. In order to fit the door back on to the cooker, do the inverse. When fitting, ensure that the notch of the hinge is correctly placed on the protrusion of the hinge holder. After the door is fitted to the oven, the safety catch should be carefully lowered down again. If the safety catch is not set it may cause damage to the hinge when closing the door.

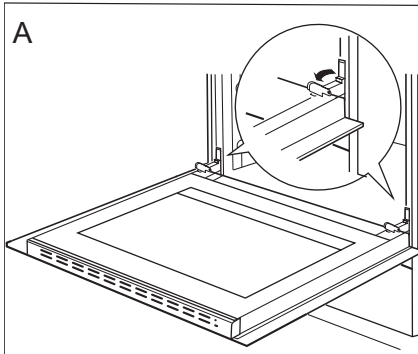

*Tilting the hinge safety catches*

## Removing the inner panel

1. Using a flat screwdriver unhook the upper door slat, prying it gently on the sides (fig. B).
2. Pull the upper door slat loose. (fig. B, C)

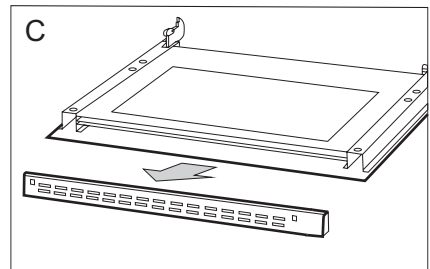
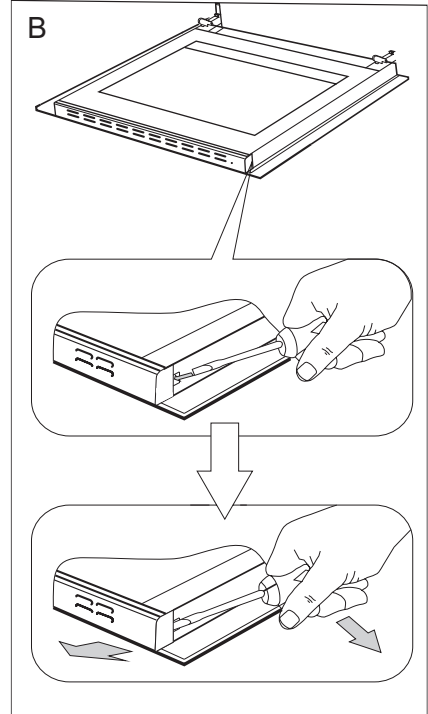

## CLEANING AND MAINTENANCE

---

3. Pull the inner glass panel from its seat (in the lower section of the door).  
Fig. D.

4. Clean the panel with warm water with some cleaning agent added.  
Carry out the same in reverse order to reassemble the inner glass panel. Its smooth surface shall be pointed upwards.

**Important! Do not force the upper strip in on both sides of the door at the same time.** In order to correctly fit the top door strip, first put the left end of the strip on the door and then press the right end in until you hear a “click”. Then press the left end in until you hear a “click”.

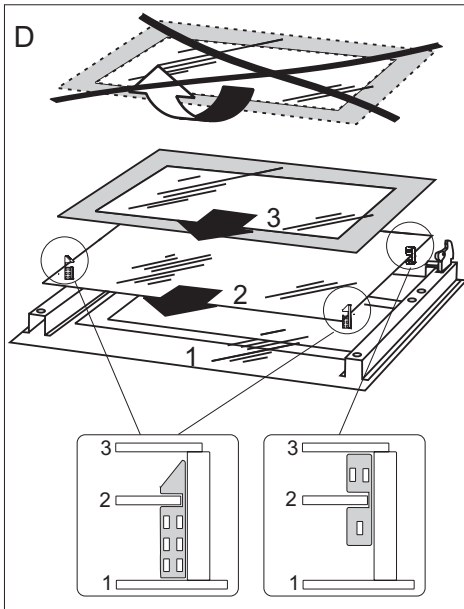

## CLEANING AND MAINTENANCE

---

### ▶ Regular inspections

Besides keeping the oven clean, you should:

- carry out periodic inspections of the control elements and cooking units of the cooker. After the guarantee has expired you should have a technical inspection of the cooker carried out at a service centre at least once every two years,
- fix any operational faults,
- carry out periodical maintenance of the cooking units of the oven.

### Caution!

All repairs and regulatory activities should be carried out by the appropriate service centre or by an appropriately authorised fitter.

## OPERATION IN CASE OF EMERGENCY

---

In the event of an emergency, you should:

- switch off all working units of the oven
- disconnect the mains plug
- call the service centre
- some minor faults can be fixed by referring to the instructions given in the table below. Before calling the customer support centre or the service centre check the following points that are presented in the table.

PROBLEM	REASON	ACTION
1. The appliance does not work.	Break in power supply.	Check the household fuse box; if there is a blown fuse replace it with a new one.
2. The oven lighting does not work.	The bulb is loose or damaged.	Tighten up or replace the blown bulb (see ' <i>Cleaning and Maintenance</i> ').

## TECHNICAL DATA

---

Electrical supply	230 V ~50Hz
Maximum load	3,1 kW
Bottom heater	1,1 kW
Top heater	0,9 kW
Grill	2,0 kW
Ultra-fan	2,0 kW
Usable capacity of the oven*	65-72 litres
Energy rating	on the energy label
Oven dimensions H/W/D	59,5 / 59,5 / 57,5 cm
Weight	approx. 35 kg
Complies with EU regulations	EN 60335-1, EN 60335-2-6 standards

\* according to EN 50304  
the capacity depends on the oven fittings – indicated on the energy label.

### *Certificate of compliance CE*

*The Manufacturer hereby declares that this product complies with the general requirements pursuant to the following European Directives:*

- *The Low Voltage Directive 2006/95/EC,*
- *Electromagnetic Compatibility Directive 2004/108/EC,*
- *ErP Directive 2009/125/EC,*

*and therefore the product has been marked with the **CE** symbol and the **Declaration of Conformity** has been issued to the manufacturer and is available to the competent authorities regulating the market.*









---