



Instruction Manual

**Car Audio system with Bluetooth,
MP3 & FM/AM Radio**

Model No: CA-2791BT

CONTENTS

1. Contents.....	01
2. Front Panel Instruction.....	02
3. Basic Operation.....	03
1. Power On/Off.....	03
2. Model Switching.....	03
3. Setting The Volume.....	04
4. Muting The Player.....	04
4. FM /RDS Radio Operation.....	04
5. Music Playback.....	06
6. Bluetooth Function.....	06
7. 2.1 AMP USB Charging.....	07
8. AUX In.....	07
9. Connection of External Amplifier.....	07
10. Installation.....	07
11. Wiring Diagram.....	07
12. Remote Controller.....	07
13. Warning.....	08
14. Precautions.....	08
15. Performance Index.....	09
15. Troubleshooting.....	10

【Front Panel Instruction】

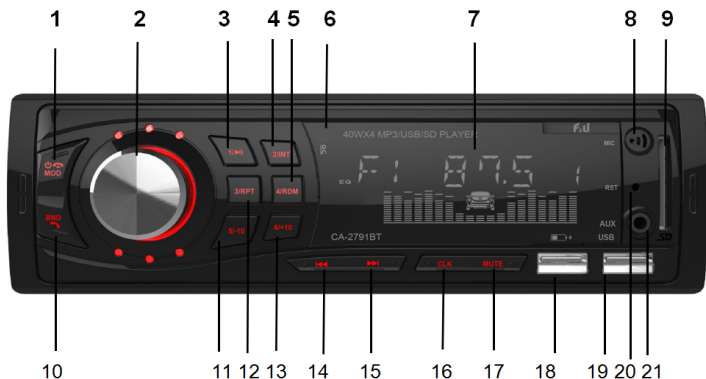

1. Power ON/ OFF and Mode switching (FM/USB/SD/AUX/Bluetooth). Dialing a call when connecting Bluetooth.
2. SEL (turning knob for volume control and menu navigation)
3. FM program slot 1/ play/pause
4. FM program slot 2/ track intro
5. FM program slot 4/ random playback
6. Remote control sensor
7. LCD display
8. Microphone
9. SD card slot
10. Band selector: automatic tuning: FM1/FM2/FM3; Hang up the call when connecting Bluetooth.
11. FM program slot 5/ 10 tracks back. Folder backward
12. FM program slot 3/ repeat
13. FM program slot 6/ 10 tracks forward. Folder backward
14. "Back" button/ Fast backward
15. "Next" button/ Fast forward
16. Clock



- 17. Mute (turns off speakers)
- 18. USB for charging
- 19. USB for audio
- 20. Reset button
- 21. Aux-IN (stereo input socket for 3.5mm plug)

【Main functions】

- Maximum supported capacity: 32GB USB/SD/ MMC card with MP3 files
- Supported audio formats: WMA, MP3, ID3 display
- Multi color LCD display
- Bluetooth function.
- FM /RDS radio.
- 2.1A charging for mobile phone

【Basic Operation】

1. Power on/off

Press the  button to turn the player on. Long press the  button again to turn off the player, then the display shows the current time

- Starting your vehicle's engine can create voltage fluctuations; therefore, only turn on the player when the engine is already running. Conversely, first stop the engine, and only then turn off the player.
- When you turn on the player, it recalls the last volume and tone settings.
- When the player is turned off, the display shows the current time

2.Mode switching

You can choose from the following sources by pressing the **MODE** button:

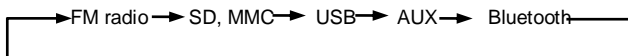

- When you press for over 2 second, it will return to the main menu.
- When you turn on the player it reverts to the last used signal source.
- If the USB and SD sockets are empty, only the FM radio and AUX modes are available
- If an external unit is connected to both the USB port and the SD socket, then the USB port takes priority. In this case you cannot select the SD input by pressing the **MODE** button.
- The player always starts playback from the last connected external unit. E.g., if you have a memory stick connected to the USB port and then plug in an SD card, the card becomes active and playback starts automatically.

3. Setting the volume

Turn the **SEL** button to adjust the volume to the desired level.

- If the player is currently not in the volume control mode, then keep pressing the turning knob until you reach the VOL mode.
- If you make no change for 3 seconds, the player automatically reverts to the previous function.
- You can adjust the volume between 0 and 63. When the volume is set to "0", the speakers switch off.

Press the **SEL** button repeatedly to select the setting you wish to adjust:

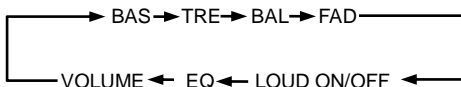

You can adjust the setting by turning the knob.

- If you make no change for 3 seconds, the player automatically reverts to the previous function.

•By default, the knob adjusts the volume

BASS	Adjust bass tone (-7....00...+7)
TREBLE	Adjust treble tone (-7....00...+7)
BALANCE	Adjust left/right balance (L15...01/00/R01...15)
FADER	Adjust front rear balance (R15...01/00/F01...15)
EQ	Adjust POP/CLASSIC/ROCK/EQ OFF
LOUD OFF/ON	Adjust LOUD OFF /LOUD ON
VOLUME	Volume control (00-63)

4. Muting the player

You can immediately mute play back without turning off the player or changing the volume, by pressing the **MUTE** button. Pressing the button again returns to the original volume level..

- When the player is muted the display shows "MUTE".
- When the player is muted the dual VU meter switches off.

【FM Radio Operation】

When you turn on the player, the FM receiver will come on if it was the last selected signal source, or if you have removed the last used USB stick or SD card. If needed, press the **MODE** button to select the FM Radio function.

If there are enough channels available, the player will move on to FM2 and FM3 after filling in the six slots of first band FM1.





- The player can store up to 18 FM radio stations (FM1/FM2/FM3 with 6 channels each).
- Keep in mind that the receiver may skip weaker stations, and you cannot change the order in which the stations are stored.
- If you wish to store a station in a particular slot, you need to manually tune in to its frequency and store it.

•If you are using the receiver at a distant place from the location where you originally stored a station (e.g., when you are traveling), you may need to find the same station again at a different frequency. The same stations often air at different frequencies in different geographical locations!

1. Selecting a stored frequency

Press the button corresponding to the station's slot (1...6) briefly. Make sure to select the right band (FM1/FM2/FM3) first by pressing **BAND**.

2. Manual Tuning, Storing Frequencies

Press the  and  button briefly to manually tune in to the desired station or press and hold the  and  button to scan automatically for the stronger stations. The scan stops when the player reaches the next available station.

3. Radio intro function

When you listen to the radio, press and hold the button **2/INT**, then it comes to the state of radio intro mode, the player plays the first 10 seconds of all available radio stations. Radio intro mode will be exited when any key is pressed.

4. RDS function

Press **SEL** button shortly to open the RDS function from AF --TA -- PPY ---OFF.



【Music Playback from USB/SD/MMC Storage Devices】

1. If you wish to listen to MP3 tracks from a USB/SD/SDHC/MMC storage device and the FM receiver is currently active, you simply need to connect the USB stick or insert the memory card. The player detects this and starts playback automatically. The display then shows the song name, the track's number and the elapsed time.

If both a USB stick and an SD/SDHC/MMC card is connected at the same time, the player will play the tracks from the one you inserted last.

- If both a USB stick and an SD/MMC card is connected at the same time, the player will play the tracks from the one you inserted last.
- If the player emits no sound or does not recognize the USB/SD/SDHC/MMC memory, remove the storage device and connect it again. If this does not work either, press the **MODE** button to select the signal source.

2. Press **1/PLAY** button to toggle between playback and pause.

3. Press  and  repeatedly to move to the previous or next track. Track number appears on the display. If you press and hold these buttons, you can fast forward or backward the current track. Play starts from when you release the button.

4. During the playback, press **2/INT** to track intro function, the player plays the first 10 seconds of every available MP3 track. If you choose to play an entire track, press **2/INT** again to exit the intro mode and continue playing the current track.

5. If you press **3/RPT** button during playback, the player will change the repeat mode (single repeat, playlist repeat, repeat all).
6. If you press **4/RDM** button during playback, the player will play all available tracks in a random order. If you press the button again, playback will continue in the original order.
7. Press **5/-10** and **6/+10** buttons to jump 10 tracks forward or backward during playback. If there are less than 10 tracks remaining at the start or end of the playlist, the player goes to the first or last track.
8. You also can use these buttons to jump folders forward or backward during playback. Press **5/-10** for over 2 seconds, you can choose the former folder, and **6/+10** for over 2 seconds, you can choose the next folder

【Bluetooth Function】

Please make sure your mobile phone supports Bluetooth and that it is connected before use. On the Mobile phone, select the product's Bluetooth device then connect it. The LCD will show the icon of BT after successful paired.

1. Connect a phone, then you can playback the music of the phone.
2. The interface will show the phone number when a call is incoming. Press **MODE** button to answer and press **BAND** button to hang up.

【USB 2.1 Amp charging function for mobile phone】

You can connect your mobile with the USB port directly through your USB cable when the device is turned on, 2.1 A current is supplied to charge your phone.

【AUX IN】

You can connect any external device with a headphone output to the front panel through a 3.5 mm stereo Jack. You can listen to these portable devices in good quality through your car radio speakers if you select the **AUX** mode by pressing the **MODE** button.

【Connecting an External Amplifier】

The preamp output at the back of the head unit allows you to connect an external amplifier or active sub box with a low input level to the player.

This way you can achieve even better volume and sound quality. White RCA socket: left channel output; Red RCA socket: right channel output.

【Installation】

1. This Player must be installed by professionals if possible.
2. Please wire the cables in strict accordance with the drawings and specifications. Wrong wiring will cause damage to the device.
3. The power cord shall be connected upon wiring all other parts.
4. All exposed wires shall be insulated to prevent short circuit.
5. All loose wires shall be fixed upon installation.

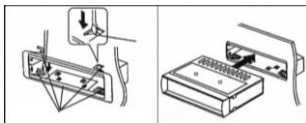

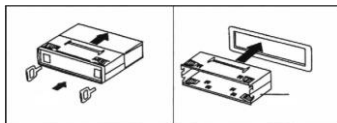

【Wiring Diagram】

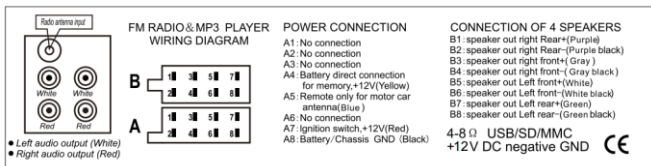

【Remote Controller】

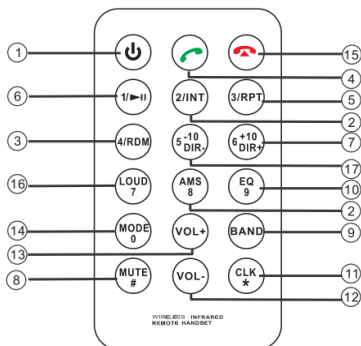

- | | |
|---|------------------------------------|
| 1 Power ON/OFF button | 2 Track intro |
| 3 Random playback | 4 Answer the phone |
| 5 Repeat playback | 6 Play/pause button |
| 7 10 tracks forward. Folder backward | 8 Mute |
| 9 Band for FM1/FM2/FM3 | 10 EQ |
| 11 Automatic tuning/ storage when you press and hold it for 2 seconds | |
| 12 Volume down | 13 Volume up |
| 14 Mode switch | 15 hang up the phone |
| 16 Loud ON/OFF | 17 10 tracks back. Folder backward |

【Warnings】

- Before starting to use the player, read these instructions carefully, then keep them in an accessible place for future reference.
- If needed, consult a technician before installing the player to avoid damaging the product or your vehicle.
- Do not listen to the player too loud. Set a volume that allows you to hear external sounds while driving. Extreme volume levels can also cause permanent damage to your ears.
- Spend as little time as possible watching the display. Doing so can distract your attention from the road, and result in accidents.
- Do not disassemble or tamper with the player, as that can cause fire, accidents, or electric shock. Incorrect use or installation renders the warranty void.
- Only for use in cars with a 12V battery and a negative ground. Using the player for any other purpose can result in electric shock, damage, or fire. The player was designed exclusively for use in vehicles.
- Always use melting fuses with the proper values. When replacing a fuse, make sure that the new fuse has the same nominal value as the one you are replacing. Using a different fuse can cause fire or damage.
- Make sure to connect the player correctly. Incorrect connections can result in fire or other damage.
- Before connecting/installing the player disconnect the negative pole of the car's battery. Doing so helps you prevent electric shock or short circuits.
- While installing the player never cut through cables or damage their insulation. Doing so can result in short circuit and fire.
- Before drilling holes or inserting screws into your vehicle's body make sure you do not damage tubes or electric wires on the other side of the cover.
- The warranty is not applicable for damage caused by irresponsible or improper installation or use.

【Precautions】

CLEANING

Use a soft, dry cloth and a brush for regular cleaning. To remove stronger stains, wet the cloth slightly with water. Avoid scratching the display's surface; never wipe the display when it is dry, and do not use a coarse cloth to clean the display. Do not use detergents. Make sure no liquid gets inside the product or onto the connectors!

TEMPERATURE

Before turning on the player make sure that the temperature inside the car is between $-20\text{ }^{\circ}\text{C}$ and $+55\text{ }^{\circ}\text{C}$, as the product is only guaranteed to operate properly within this temperature range. Extreme weather conditions can damage the product.

FINDING THE RIGHT LOCATION AND INSTALLATION

When installing the product, make sure it will not be exposed to any of the following:

- direct sunlight or heat (e.g. from the heating system)
- wetness, high humidity
- a significant amount of dust
- strong vibration

If installed angle exceeds 30 degrees from horizontal, the unit might not give its optimum performance.

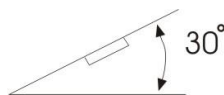

PROPER USAGE OF USB STICKS/SD CARDS

To avoid malfunction and errors, please observe the following:

- Carefully read the instructions of the USB/SD storage device or media player.
- Do not touch the connectors with your hand or any object; keep the connectors clean.
- Protect the USB/SD device from strong shocks.
- Do not bend, drop, disassemble or modify these devices, and protect them from humidity!

Do not use or store the devices in the following locations:

- Anywhere inside the vehicle where they are exposed to direct sunlight or high temperature.
- Any place with a high humidity or where corrosive materials are present.
- Place the devices in a location where they do not hinder you in driving.

Further important notes:

- USB/SD memory devices may not function properly at extremely high or low temperatures.
- Only use high-quality USB/SD devices. Depending on their type and condition, even such high-quality products may not always work properly. The proper operation of these devices is not always guaranteed.
- Depending on the type and condition of the USB/SD device and the settings used in the software that encoded the MP3 files, the player may not detect or play back certain files.
- The player is not guaranteed to play copy-protected files (legal copyright protection).
- The USB/SD memory device may need a certain amount of time before playback can start. If the device also includes non-audio files, the time needed for playback to start may be significant.
- The product can play files with an .mp3 extension. Do not use this extension on files that do not contain pure audio data. The player cannot process such non-audio data. The noise emitted when playing such files can damage the speakers and/or amplifiers.
- Do not remove the USB/SD device while playback is in progress. In order to protect it from potential damage, first switch to a different signal source by pressing the MODE button, and only then remove the USB/SD device.
- If you connect a portable audio player instead of a USB/SD memory through the USB port, and the device has an MSC/MTP setting, choose the MTP option. The remarks above also apply when you are connecting an audio player.
- Do not connect the negative pole of the speakers with the negative pole (ground) of the vehicle or the power source!

【Performance Index】

FM TUNER

FM frequency range.....	87.5 - 108.0 MHz
Usable sensitivity.....	3.0 μ V
Sensitivity.....	30 dB S/N >10 dB
IF frequency.....	10.7 MHz
Channel separation.....	>45 dB
Signal/noise level.....	>50 dB

USB/SD/MMC

USB system.....USB 1.1/2.0
 Max. Current.....500 mA
 File system.....FAT 12/16/32
 MP3 decoder.....MPEG-1/2 AUDIO Layer-3
 Number of channels.....2-CH, stereo
 Channel separation.....>55 dB
 Signal/noise level.....>60 dB

GENERAL PARAMETERS

Car Voltage system.....12 Volt Negative GND chassis
 Operation Voltage.....14,4 V DC (11 - 15 V)
 Channels of amplifier.....4CH
 Power output.....4x 40 W max.
 Speaker impedance.....4-8 Ohm
 Frequency range.....20 - 20.000 Hz
 Pre-amp output.....1.2V max. (2 x RCA)
 Tone regulationBass, treble, classic, pop,
 T operation.....-20°C +55°C
 Weight.....0.7 kg
 Chassis dimensions.....178 x 99 x 50mm

【Troubleshooting】

Before going through the check list, check the wiring connection diagram firstly. If any of the problems persist after checklist has been made, consult your nearest service dealer.

Symptom	Causes	Solution
No Power	The car ignition key has not been switched on	If the power supply is properly connected to the car accessory terminal, switch the ignition key to ACC
	The fuse is blown down	Replace a new fuse
No Sound	Volume is at minimum	Adjust volume to desired level
	Wiring is not properly connected	Checking wiring connection
	Mute state	Turn off the mute function
Sound Skipping	The installation angle is more than 30°	Adjust the installation angle to less than 30°

The Operation button do not work	The built-in microcomputer is not operating properly due to interference	Press the RESET button.
The Radio or automatic selection does not work	The antenna cable is not connected correctly	Connect the antenna cable correctly
	The signals are too weak	Select the station manually

NOTICE ABOUT RECYCLING



Your product is designed and manufactured with high quality materials and components which can be recycled and reused.

This symbol means that electrical and electronic equipment, at their end-of-life, should be disposed of separately from your household waste.

Please dispose of this equipment at your local community waste collection/ recycling centre. In the European Union there are separate collection systems for used electrical and electronic products. Please help us to conserve the environment we live in!

DECLARATION OF CONFORMITY

Herewith, Amiridis-Savvidis S.A. states that this product, complies with the requirements of below directives:

RED Directive 14/53/EU

RoHS Directive 11/65/EU

CE-marking Directive 93/68/EEC



The detailed declaration of conformity can be found at www.fandu.gr

Exclusive importer in Greece:

Amiridis – Savvidis S.A.

87A, 17th Noemvriou str, P.C. 55534

Thessaloniki – Greece

T: +302310944944 | F: +302310944940

www.amiridis-savvidis.gr