

UNITED®

INSTRUCTIONS MANUAL

INDUSTRIAL WALL FAN (20", 24", 26", 30")

WITH REMOTE CONTROL

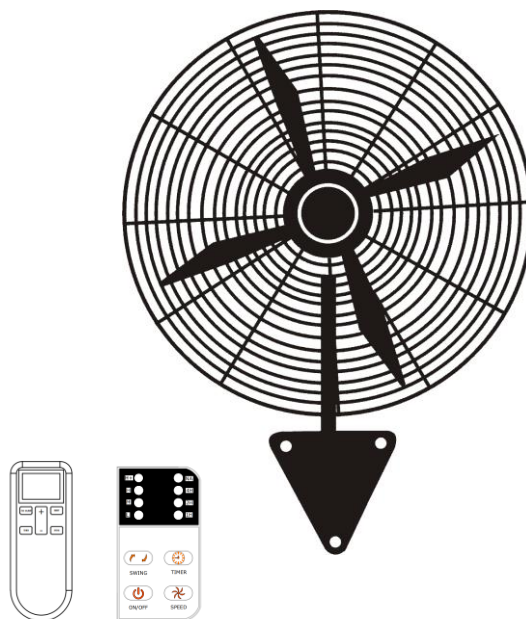

MODELS: UIF-763, UIF-764, UIF-765, UIF-899

READ AND SAVE THESE INSTRUCTIONS

Pictures in this manual are for reference only. You can refer to actual product

Characteristics And Use Of The Product

- Powerful / strong wind airflow / stable / safe / energy sufficient etc.
- It can be extensively used in WORKSHOPS, WAREHOUSES, GYMNASIUMS, PATIO,

Safety Instructions

PLEASE READ ALL INSTRUCTIONS CAREFULLY BEFORE USING THE PRODUCT.

WARNING: When using electrical appliances, basic precautions should always be followed to reduce the risk of fire, electric shock, and injury to persons, including the following:

1. Before using the fan, check that the supplied voltage corresponds to the one shown on the appliance nameplate.
2. Yellow and green lines of the power cable are used to connect a power line and they should be handled only by a qualified person.
3. Make sure the fan is completely assembled before operation.
4. Before the fan is turned ON, please ensure the following:
The blades have not been deformed
The blades do not touch the fan cover
The cover is in the right position and has not been deformed.
The screw nut is not loose.
5. The apparatus shall not be exposed to dripping or splashing and no objects filled with liquids, such as vases, shall be placed on the product. When operating the fan outdoors, use an extension cord suitable for outdoor use to prevent the risk of electric shock.
6. Do not allow children to play with parts of the packaging, such as plastic bags.
7. The fan should be placed away from heat sources, such as radiators, gas/electric heaters and direct sunlight.
8. The fan should not be used in the immediate vicinity of water, such as bathtubs, bathrooms, swimming pools etc.
9. Always place the fan on a stable, level surface when operating, to avoid overturning. Place the power cord away from walking paths to avoid being tripped over. The cable should be kept away from heat, sharp edges and oil.
10. Do not move the fan while in operation. Disconnect the fan and wait until the blades completely stop.
11. Ensure that the fan is disconnected from the supply mains before removing the guard.
12. This product cannot be used in explosive or dusty environments, or places with air and steam.
13. If the supply cord is damaged, it must be replaced by the manufacturer, its service agent or similarly qualified persons in order to avoid a hazard.
14. This appliance can be used by children aged from 8 years and above and persons with reduced physical, sensory or mental capabilities or lack of experience and knowledge if they have been given supervision or instruction concerning use of the appliance in a safe way and understand the hazards involved. Children shall not play with the appliance. Cleaning and user maintenance shall not be made by children without supervision.
15. Children of less than 3 years should be kept away unless continuously supervised. Children aged from 3 years and less than 8 years shall only switch on/off the appliance provided that it has been placed or installed in its intended normal operating position and they have been given supervision or instruction concerning use of the appliance in a safe way and understand the hazards involved. Children aged from 3 years and less than 8 years shall not plug in, regulate and clean the appliance or perform user maintenance.
16. Use this fan as described in the manual. Any other use, not recommended by the manufacturer, may cause fire, electric shock, or injury to persons and may void the warranty

Installation Instructions

Before using the Wall fan for the first time, read all instructions carefully and keep them in a safe place for future reference.

Remove all the sub-assemblies from the box.

NOTE: Do not operate the fan until it is completely assembled.

1. At the desired location, place the mounting plate on the wall and mark out four holes positions using a pencil.

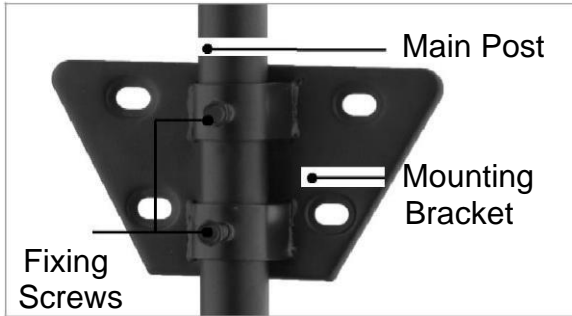

NOTE: Consider a location within a distance of 0.8m radius from a wall power outlet to make sure you can plug the unit into the power point easily.

For concrete or solid brick walls drill holes at the marked position, and then wedge the wall plugs (not provided) into the pilot holes. Hold the mounting plate to the wall, screw the mounting plate onto the wall with four screws (not provided). It is recommended to use a torque wrench to ensure that the screws are tight. If mounting on plaster board locate the studs behind the plasterboard and secure the bracket. The bracket must always be screwed to a stud when mounting on a wooden/plaster wall.

2. FAN POSITION



UPSIDE FAN POSITION:

Slide the main post over the wall bracket from the top and secure it with 2 fixing screws (not provided).



DOWNSIDE FAN POSITION:

Slide the main post over the wall bracket from the bottom and secure it with 2 fixing screws (not provided).

Use the holes at the top of the main post. Also refer to the sticker attached on the post.

3. Unscrew the fixing & stopper screw attached to the motor housing, place the motor housing in between the connector which is placed over the main post. Align the mounting holes and secure the assembly with fixing and stopper screw. It is recommended to use torque wrench to ensure that the assembly is secured and tight.

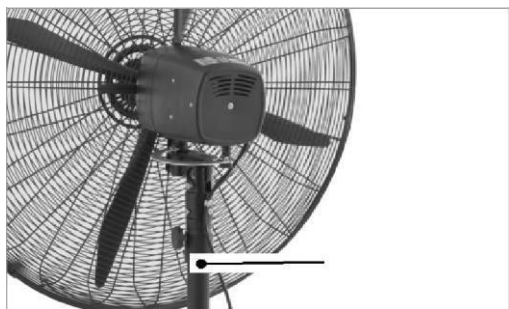

Screws Attached to the Motor Housing

4. Loosen the 4 screws & washers attached to the face of the motor housing. Place the rear grille over the motor shaft & align the mounting holes. Fix the screws and washer back to secure the assembly.

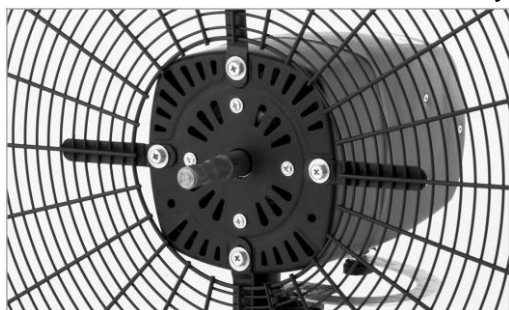

5. Slide the fan blade over the motor shaft. Align the mounting hole on the fan blade over the flat slot provided on the motor shaft; secure the assembly with the screw provided. Use a hex wrench to tighten the fan blade. Ensure the screw is fully tightened before you proceed with next step.

Motor Shaft
Screw Blade Fixture

Fan Blade

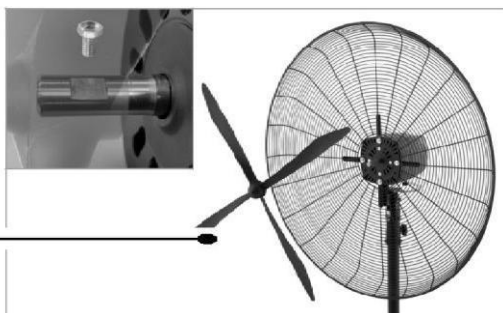

6. Open the guard clips outwards on the edge of front grille and unscrew the screw attached to the bottom of the front grille. Align the screw fixing hole with the mounting hole on the rear guard and put the screw back to secure the assembly. Close the guard clips to secure the grille. Never operate the unit without the front grille assembled completely.

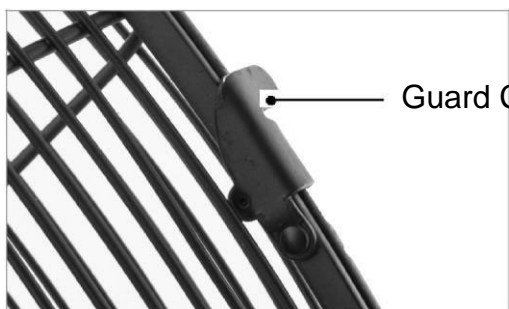

Guard Clip



- Remove the cord clamp screw, pass the cord through the clamp and fix the screw back. If the power cord is hanging loosely between the fan and the power outlet, make sure it will not obstruct the fan oscillation in any way.

Wall fan must be installed 2.5M above the ground.

Features

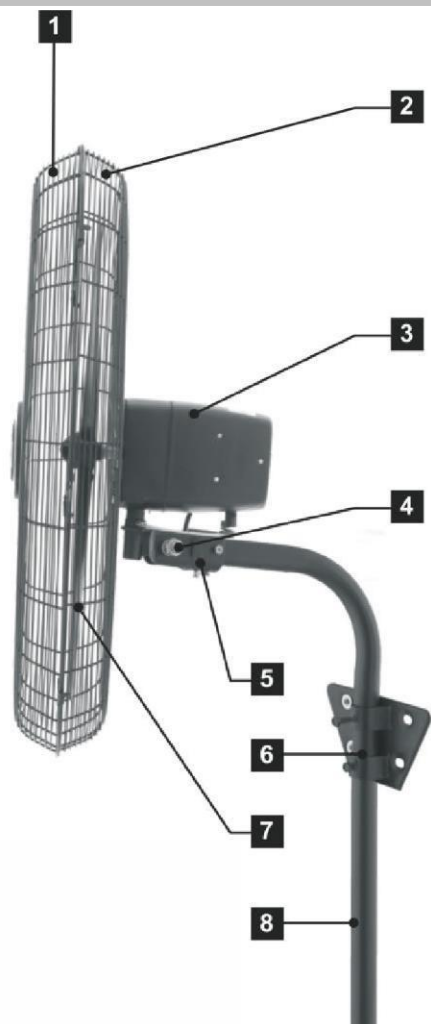

1. Front grille
2. Rear Grille
3. Motor housing
4. Tilt head adjustment
5. Connector
6. Mounting bracket
7. Fan Blade
8. Main post

Specification

Model	Blades	Size	Voltage	Power
UIF-763	4	20"	220-240V/50Hz	125W
UIF-764	3	24"	220-240V/50Hz	155W
UIF-765	4	26"	220-240V/50Hz	180W
UIF-899	3	30"	220-240V/50Hz	220W

Energy Saving Tips

- When operating with the oscillation function, do not place the fan in a position that may restrict or impede its movement.
- Do not locate the fan where furniture or other objects can obstruct the air flow
- Keep blinds/curtains closed during the sunniest part of the day

INSTRUCTIONS FOR THE REMOTE CONTROL

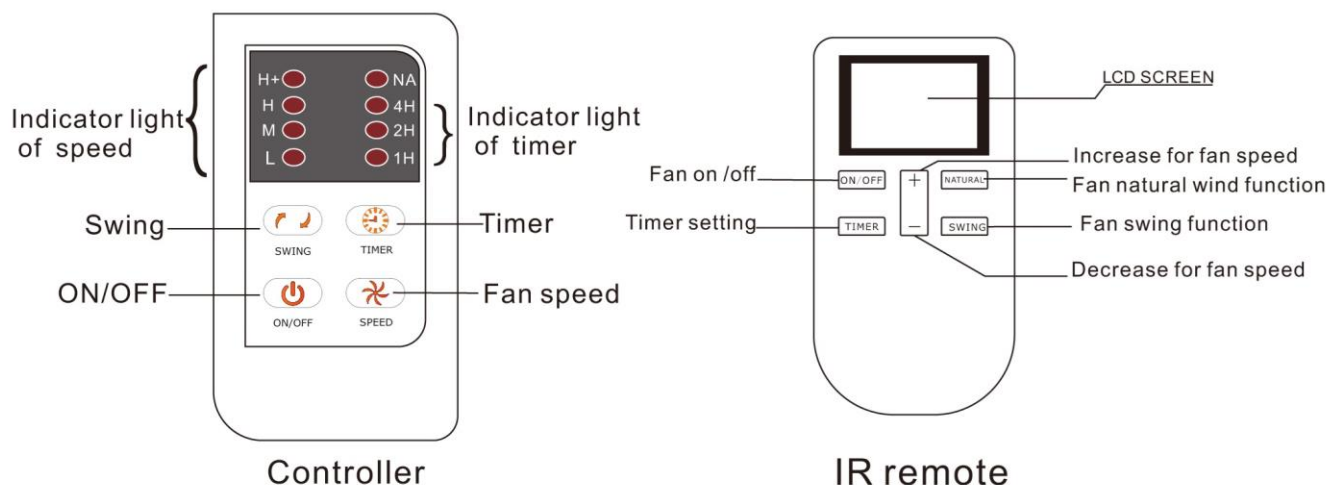

1. Controller will be connected with the fan motor, you can control the functions using the buttons. The relative indicator will light when you press the buttons.
2. You can turn the fan ON/OFF, adjust the speed, turn ON/OFF oscillation function, control the timer function.
3. Keep the IR remote towards the fan controller when you use it. The relative functions will be shown on LCD screen and the indicator light will turn ON at the same time.
4. You can set the timer as 1, 2, 3, up to 7 hours using the remote control. When setting is done, you can see the relative light indicator on the controller.
5. You can select between 4 speed settings
6. If the remote does not operate check if the batteries are empty.
7. How to use the handset remote:

Step 1: Fit 1.5V type battery into the remote



Step 2: Power ON the fan from the mains socket and press ON/OFF button on the remote, pointing the remote towards the direction of the fan.

IMPORTANT NOTICE:

Keep the remote control away from wet conditions

Keep the fan away from conditions as described in safety instructions

When the fan is not used for a long period of time, take out the batteries.

Use And Care

1. This product is intended for commercial, industrial or outside use.
2. To protect against electrical shock, do not place the fan in window, do not immerse the unit, plug or cord in water, do not spray with liquids.
3. Close supervision is necessary when any appliance is used by or near children.
4. Unplug the fan from outlet when not in use, when moving fan from one location to another and before cleaning.
5. Do not operate the fan in the presence of explosive and/or flammable fumes.
6. Do not operate the fan with a damaged cord, plug, after a malfunction or if dropped or damaged in any manner.
7. Do not operate the fan or any parts near an open flame, cooling or other heating appliance.
8. Avoid contact with moving fan parts.
9. To disconnect, grip the plug and pull it from the wall outlet. Never pull by the cord.
10. The use of attachments not provided by the supplier is not recommended and may cause hazardous.
11. Do not operate the fan if the housing is removed or damaged

NOTICE ABOUT RECYCLING



Your product is designed and manufactured with high quality materials and components which can be recycled and reused.

This symbol means that electrical and electronic equipment, at their end-of-life, should be disposed of separately from your household waste. Please dispose of this equipment at your local community waste collection/ recycling centre.

In the European Union there are separate collection systems for used electrical and electronic products.

Please help us to conserve the environment we live in!

DECLARATION OF CONFORMITY

Herewith, Kalliopi Karyda & Co Lp states that this product, complies with the requirements of below directives:

EMC-Directive: 14 / 30 / EU

Low Voltage Directive: 14/ 35 / EU

CE Marking: 93 / 68 / EEC

RoHS Directive: 11 / 65 / EU & 15 / 863 / EU

The detailed declaration of conformity can be found at www.united-electronics.gr



Exclusive importer in Greece:

Kalliopi Karyda & Co Lp

87A, 17th Noemvriou str, P.C. 55534

Thessaloniki – Greece

T: +302316006600 | F: +302316006650

www.united-electronics.gr